

CLEARANCE TABLE

SERIES #	A	B	C
40, 45	.069	.050	.019
41	.050	.045	.005
42	.049	.045	.004
44	.106	.085	.021

SCREW LENGTH AND HEAD STYLE DEPEND ON DETAILS OF THE APPLICATION. IN GENERAL, THE SCREW SHOULD NOT EXTEND BEYOND THE BOTTOM FACE OF THE WEDGE BODY.

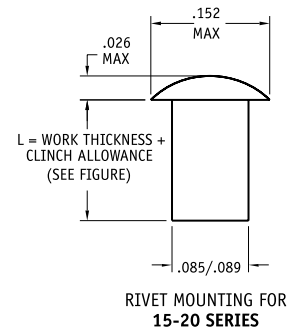
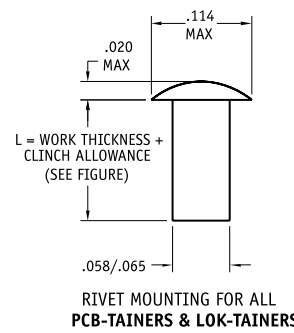
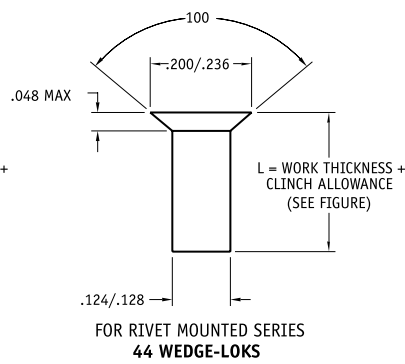
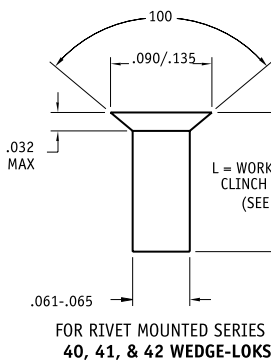
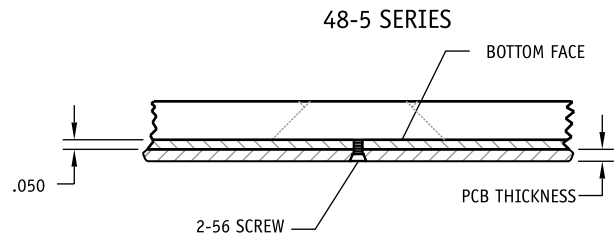
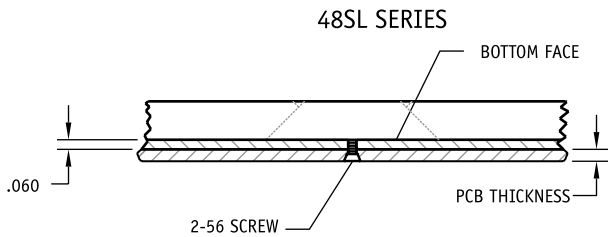
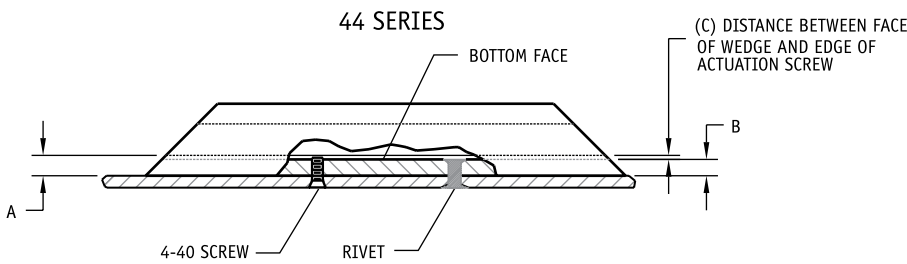

SUGGESTED RIVET DIMENSIONS

