

# User Manual

## 1 U MTCA Shelf



**Product Number:**  
**11850-023**

R1.0	January 2015	Initial release
R1.1	April 2016	Minor corrections

Impressum:

Schroff GmbH

Langenalber Str. 96 - 100  
75334 Straubenhardt, Germany

The details in this manual have been carefully compiled and checked - supported by certified Quality Management System to EN ISO 9001/2000

The company cannot accept any liability for errors or misprints. The company reserves the right to amendments of technical specifications due to further development and improvement of products.

Copyright © 2016

All rights and technical modifications reserved.

---

<b>1</b>	<b>Safety .....</b>	<b>1</b>
1.1	Safety Symbols used in this document.....	1
1.2	General Safety Precautions .....	1
1.3	References and Architecture Specifications.....	1
<b>2</b>	<b>Hardware Platform .....</b>	<b>2</b>
2.1	Front and Rear View.....	3
2.2	ESD Wrist Strap Terminal .....	3
<b>3</b>	<b>Backplane .....</b>	<b>4</b>
3.1	Backplane Topology .....	4
3.2	Power Management.....	4
<b>4</b>	<b>Cooling .....</b>	<b>5</b>
4.1	Air Filter.....	5
4.2	Air filter swap .....	5
4.3	Airflow .....	5
4.4	Cooling characteristic.....	6
4.5	Power Supply.....	7
<b>5</b>	<b>Technical Data .....</b>	<b>8</b>





# 1 Safety

The intended audience of this User's Manual is system integrators and hardware/software engineers.

## 1.1 Safety Symbols used in this document

	<p><b>Hazardous voltage!</b></p> <p><i>This is the electrical hazard symbol. It indicates that there are dangerous voltages inside the Shelf.</i></p>
---	---

	<p><b>Caution!</b></p> <p><i>This is the user caution symbol. It indicates a condition where damage of the equipment or injury of the service personnel could occur. To reduce the risk of damage or injury, follow all steps or procedures as instructed.</i></p>
---	--

	<p><b>Danger of electrostatic discharge!</b></p> <p><i>The Shelf contains static sensitive devices. To prevent static damage you must wear an ESD wrist strap.</i></p>
---	--

## 1.2 General Safety Precautions

	<p><b>Warning!</b></p> <p><i>Voltages over 60 VDC can be present in this equipment. As defined in the PICMG 3.0 Specification, this equipment is intended to be accessed, to be installed and maintained by qualified and trained service personnel only.</i></p>
---	---

- Use of this product in a manner not specified by the manufacturer may impair the safety protection of this equipment.
- Service personnel must know the necessary electrical safety, wiring and connection practices for installing this equipment.
- Install this equipment only in compliance with local and national electrical codes.
- For additional information about this equipment, see the PICMG MicroTCA Specification ([www.picmg.com](http://www.picmg.com)).

## 1.3 References and Architecture Specifications

- PICMG<sup>®</sup> MTCA.0 Specification ([www.picmg.com](http://www.picmg.com))
- PICMG<sup>®</sup> AMC<sup>®</sup> Base Specification ([www.picmg.c](http://www.picmg.c))

## 2 Hardware Platform

The Schroff **11850-023** is an 1 U/2slot MicroTCA Shelf for AMC Single Full-size or Mid-size modules (with 2 HP filler panel).

### Features:

- Shielded steel case
- 2 AMC single Full-size slots
- MicroTCA Backplane interconnects all 21 ports between both AdvancedMC modules.
- Power management controller on the backplane.
- Fan Controller on the backplane.
- Active cooling through:
  - 4 temperature controlled fans for cooling the AMC modules.
  - 1 fan for cooling the power supply.
  - Smart Fan Controller integrated on backplane
- Easy removable air inlet filter
- Integrated 150 W AC Power Supply with wide range AC input and 12 V DC output.
- AC mains/line module with IEC 320-C14 connector, integrated mains/line fuses and line filter

## 2.1 Front and Rear View

Figure 1: Front and RearView



- |   |                          |   |   |
|---|--------------------------|---|---|
| 1 | ESD Wrist Strap Terminal | 4 | Mains/line switch                       |
| 2 | 2 HP Filler panel        | 5 | Ground Terminal (Equipotential bonding) |
| 3 | AC input                 |   |   |

## 2.2 ESD Wrist Strap Terminal



### **Danger of electrostatic discharge!**

*The Shelf contains static sensitive devices. To prevent static damage you must wear an ESD wrist strap.*

The ESD Wrist Strap Terminal (4 mm banana jack) is located left to the card cage.

### 3 Backplane

- Backplane interconnects all 21 ports between both AdvancedMC modules
- 3.3 V management power generation on the backplane
- Circuitry for enabling the Payload power by AdvancedMC presence signal
- Fan connectors on the backplane (4-pin fan connectors)
- Fan speed control circuitry on backplane, triggered by temperature sensors in the chassis.

#### 3.1 Backplane Topology

Figure 2: Backplane Topology

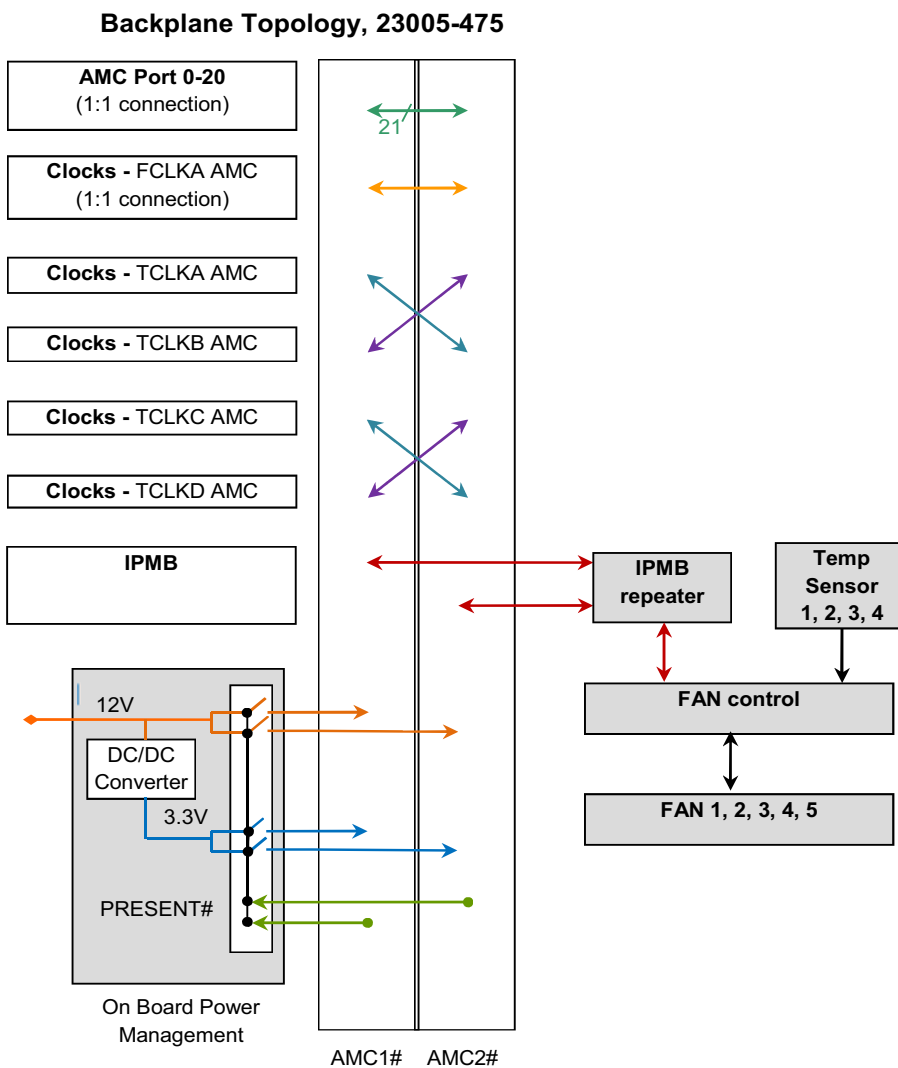

#### 3.2 Power Management

The integrated power management circuitry on the backplane provides 12 V payload power distribution branches to the AMC Slots. It also generates the 3.3 V management power and distributes it to all slots.

The current to the AMC slots is limited to:

- 8 A (Payload Power)
- 250 mA (Management Power)



## 4 Cooling

### 4.1 Air Filter

Figure 3: Air Filter



1 Air Filter

### 4.2 Air filter swap

The system provides a replaceable air filter. The air filter can be pulled out after removing the top cover. The filter meets the requirements of the Telcordia Technologies Generic Requirements GR-78-CORE specification.

### 4.3 Airflow

Figure 4: Airflow

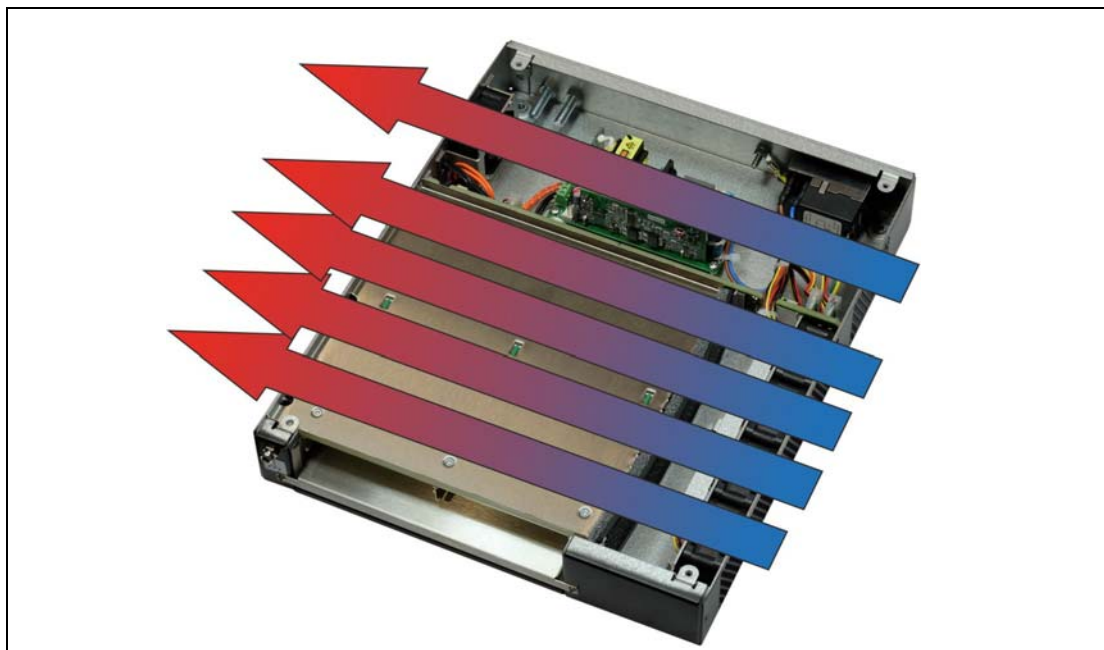

## 4.4 Cooling characteristic

The MicroTCA Shelf is equipped with four 12 VDC fans for cooling the AMC modules and one 12 VDC fan for cooling the power supply. The fans and the inlet and outlet temperature sensors are connected to the integrated fan controller on the backplane.

The fan controller adjusts the fan speed according to the difference between the inlet temperature and the outlet temperature.

Once the fan controller receives an upper non critical temperature event, the controller increases the fan speed to maximum until the event is no longer present.

Figure 5: Fan Speed vs Temperature

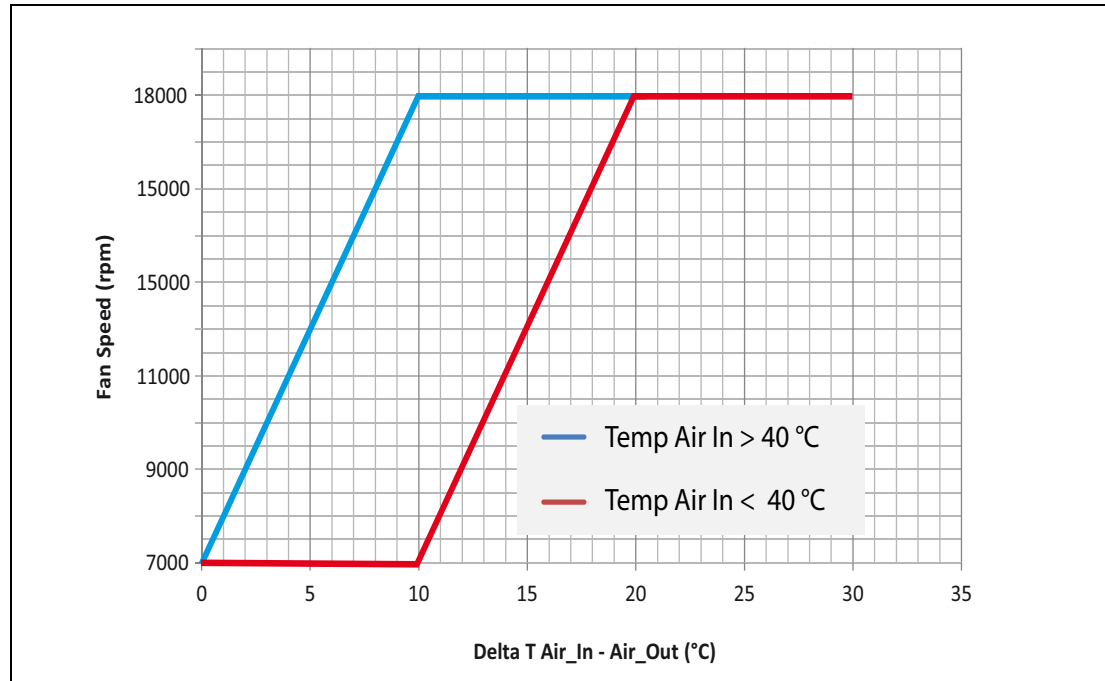
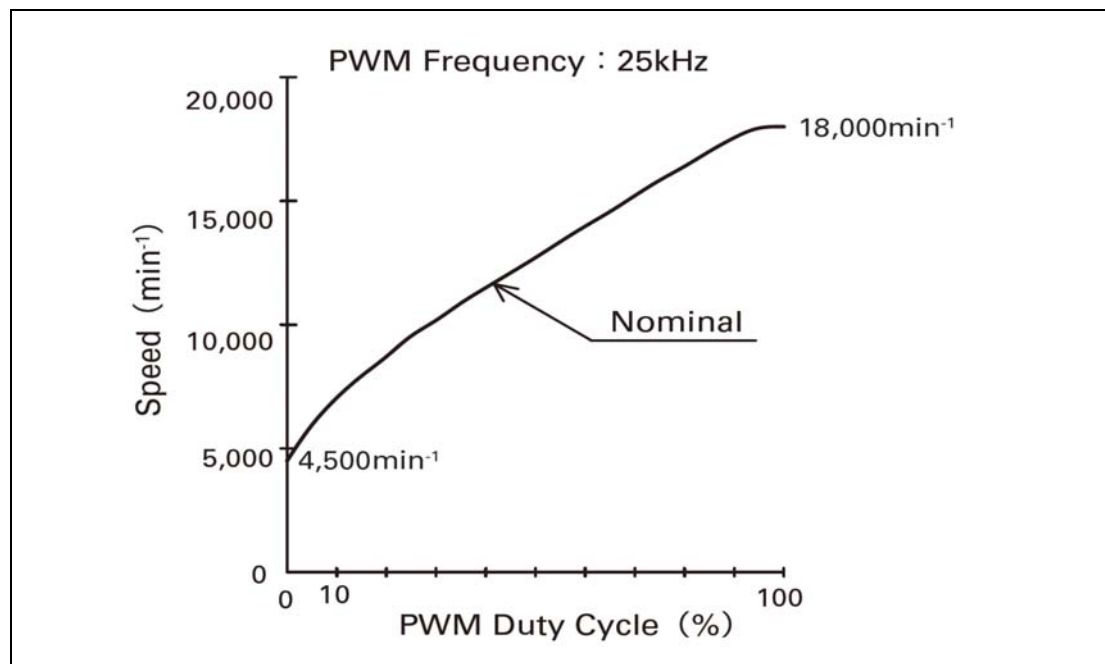

Figure 6: PWM vs Fan Speed



## 4.5 Power Supply

	<p><b>Hazardous voltage!</b> Parts of the power supply may be exposed with hazardous voltage. Always remove mains/line connector before carry out any assembly work.</p>
	<p><b>Caution!</b> The unit is designed in accordance with protection class 1! It must therefore be operated with protective earth/GND connection. Use only a three conductor AC power cable with a protective earth conductor that meets the IEC safety standards!</p>
	<p><b>Caution!</b> There is a ground terminal at the right side. This ground terminal is only for equipotential bonding. Grounding is achieved through the protective earth conductor of the power cable!</p>

The system has a 150 W open frame AC power supply with wide range AC input and 12 V DC output. The DC output is connected directly to the power management circuitry on the backplane.

The power input is provided by an AC mains/line module with IEC 320-C14 connector, integrated mains/line fuses, line filter and a mains/line switch.

Fuse value is T2AH250V.

**Figure 7: AC Input**



- |   |              |   |                       |
|---|--------------|---|-----------------------|
| 1 | AC Input     | 3 | Equipotential bonding |
| 2 | Mains switch | 4 | Fuse holder           |

**Table 1: Data AC Power Supply**

Input voltage	100 - 240 VAC
Mains Frequency	50 / 60 Hz
Output (max.)	150 W
Output voltage	12 V DC
Output voltage ripple and noise	120 mVpp
Operating Temperature	-5° C - +55° C

## 5 Technical Data

Table 2: Technical Data

<b>Physical Dimensions</b>	
Height	43.60 mm (1 U)
Width	252 mm
Depth	approx. 302 mm
<b>Weight</b>	
Weight completely assembled	approx. 2 Kg
<b>Power Supply</b>	
Input Voltage	100 VAC to 240 VAC
Mains Frequency	50 Hz to 60 Hz
Input Current	1,2 A at 100 VAC; 0,5 A at 240 VAC
Input Fuse (2x)	T2AH250V
<b>Environmental</b>	
Ambient temperature	-5°C...+45°C (long term)
Ambient temperature	-5°C...+55°C (short term)
Humidity	+5%...+85%, non-condensing



**Schroff GmbH**

Langenalber Str. 96 - 100  
75334 Straubenhardt, Germany  
Tel +49.7082.794.0  
Fax +49.7082.794.200