

CLEARANCE TABLE

SERIES #	A	B	C
40, 45	.069	.050	.019
41	.050	.045	.005
42	.049	.045	.004
44	.106	.085	.021

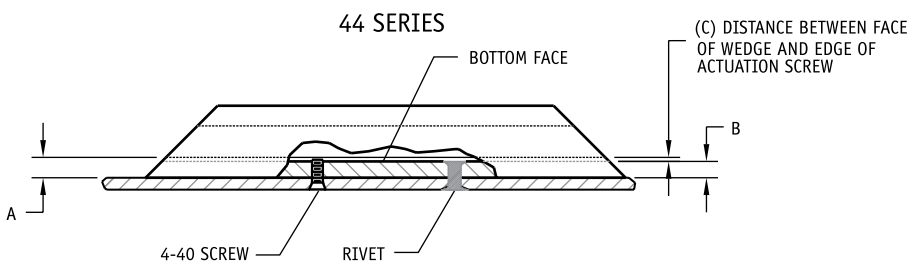

SCREW LENGTH AND HEAD STYLE DEPEND ON DETAILS OF THE APPLICATION. IN GENERAL, THE SCREW SHOULD NOT EXTEND BEYOND THE BOTTOM FACE OF THE WEDGE BODY.

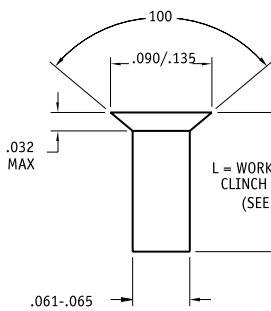
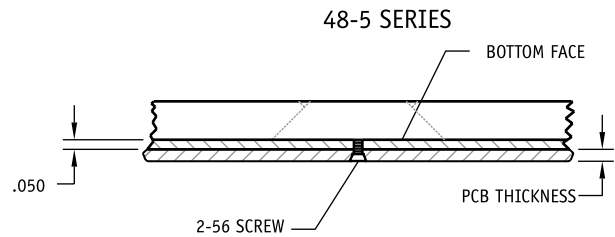
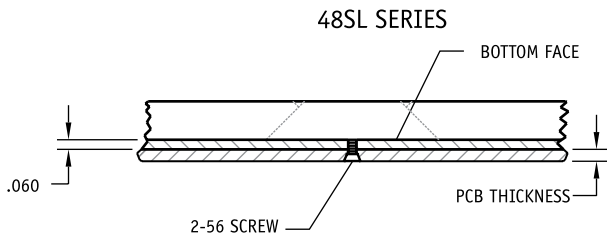

FOR RIVET MOUNTED SERIES 40, 41, & 42 WEDGE-LOKS

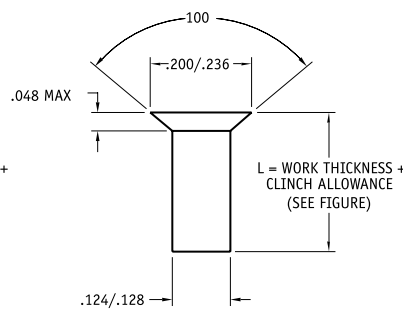

FOR RIVET MOUNTED SERIES 44 WEDGE-LOKS

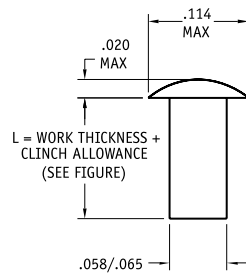

RIVET MOUNTING FOR ALL PCB-TAINERS & LOK-TAINERS

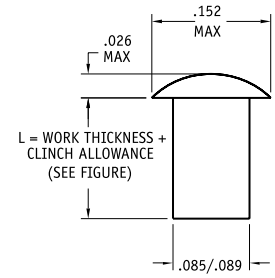

RIVET MOUNTING FOR 15-20 SERIES

SUGGESTED RIVET DIMENSIONS

